



GRILL CABIN 14.9



PRODUCT DESCRIPTION

Spacious Grill Cabin 14.9 m² gives a great opportunity for a big group of friends or a large family to rest and at the same time enjoy delicious grilled steaks. This grill cabin can be used in any weather conditions, which makes it a great meeting place.

Also, the grill cabin provides both comfort and exclusiveness to the environment. It can be painted in the desired color and therefore perfectly fit your garden.

High-quality materials ensure the longevity of a grill house and easy use. Eight cabin walls are made of rounded spruce boards with the dimensions 45 x 145 mm.

The roof is covered with bitumen shingles, and there are four double glazed windows, two of which open. Besides that, the door is decorated with an original hexagonal window.

Also, there are seven benches in the cabin; two of these benches easily transform into sleeping benches: just turn over the additional board. The floor is easily assembled from separate components.

There is a convenient wood- or charcoal-fired grill with a table around it inside the cabin.

Also, one adjustable cooking platform and two special platforms for a kettle, frying pan, etc. can be found. Above the grill, there is an adjustable chimney.

Finally, the cabin is lockable, and there is a small porch with a roof at the entrance.



SPECIFICATION

People	14-20 persons
Timber	Spruce
Shape	Octagonal
Room	1
Inside area	14.9 m ²
Total height	3325 mm
Wall height	1155 mm
Floor thickness	18 mm
Roof thickness	18 mm
Wall thickness	45 mm
External dimension	4297 x 4297 mm
Door size	782 x 1500 mm
Window size	880 x 510 mm

STANDARD SET

Wall, floor, roof panels from spruce;

Roof covered with bitumen shingles of your selected color;

Inside standard grill with cooking platforms;

Table around the grill;

Adjustable chimney;

4 double glass windows (2 of them are opening);

Door with a lock and hexagon window;

7 inside benches from spruce (2 of them are folding benches);

Cushions for benches of your selected color: brown or blue.

DELIVERY

Assembling time

9 hours

Size of pallets (LxWxH)

3.5 x 1.2 x 2.55 m

Weight

1600 kg

Grill Cabin is delivered to the customer **not assembled** but fully complete, with detailed assembly instructions and drawings, and packed on a pallet (KIT).

Two people can assemble Grill Cabin in 9 hours.

~ We pack all accessories on the same pallet if it is possible. Otherwise, all accessories will be packed on a separate pallet.

GRILL AND CHIMNEY SET



"Premium" 8-corner Grill and Chimney set



"Viking" Grill and Chimney



Standard 8-corner Grill and Chimney



Luxury Grill and Chimney



Without Grill and Chimney

OPTIONS

AVAILABLE ROOF COLOR

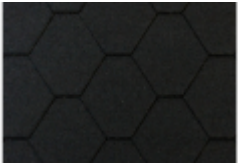

Black shingles



Green shingles



Red shingles

BENCHES AND CUSHIONS:

- Benches + brown cushions;
- Benches + blue cushions;
- Without cushions;
- Without benches and cushions.



INSULATED ROOF

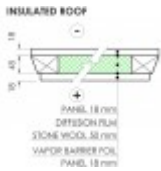

INSULATED FLOOR



TONGUE AND GROOVE FLOORS



WALLS HEIGHT

- One extra board in wall (*the height of board - 145 mm*)
- Two extra boards in wall

OPENING WINDOWS FOR GRILL CABIN 14.9

- 2 opening windows from 4 (standard);
- 3 opening windows from 4;
- 4 opening windows from 4.



ROOF PANEL WITH WINDOW



ACCESSORIES



Blue curtains set



Brown curtains set

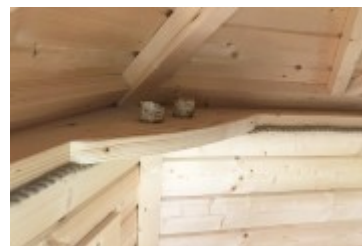

Shelf for Grill cabin



Drawer



Firewood ring



Grill cover 8 corners



Grill table safety fence 8 corners*



Wooden dishes and flatware set**



Reindeer hides



Flower pot for Pavilion and Grill



Stainless steel door sill



Door stopper

***Available "Basic", "Optimal" or "Luxury" set.*

DRAWINGS

GRILL CABIN 14.9 m² DRAWINGS

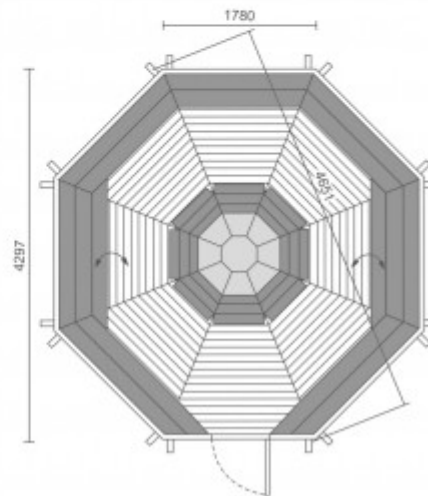
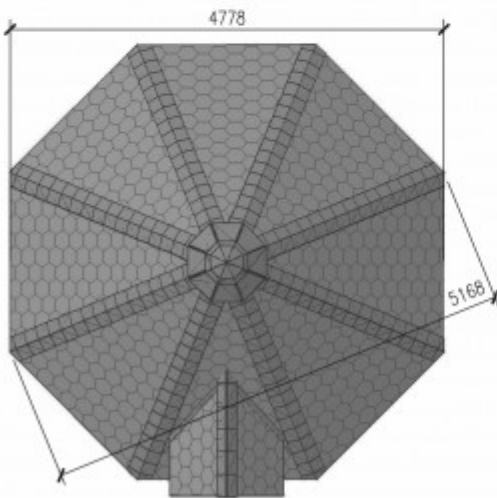
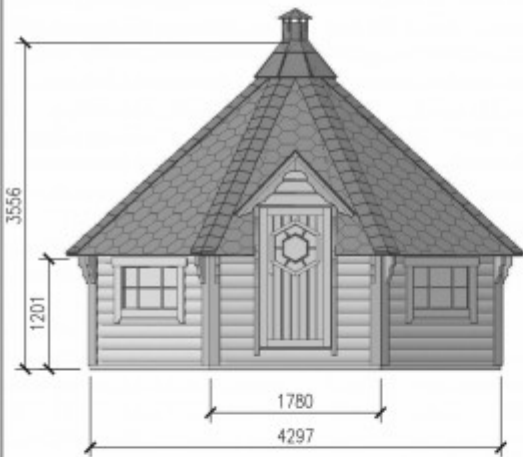

FOUNDATION

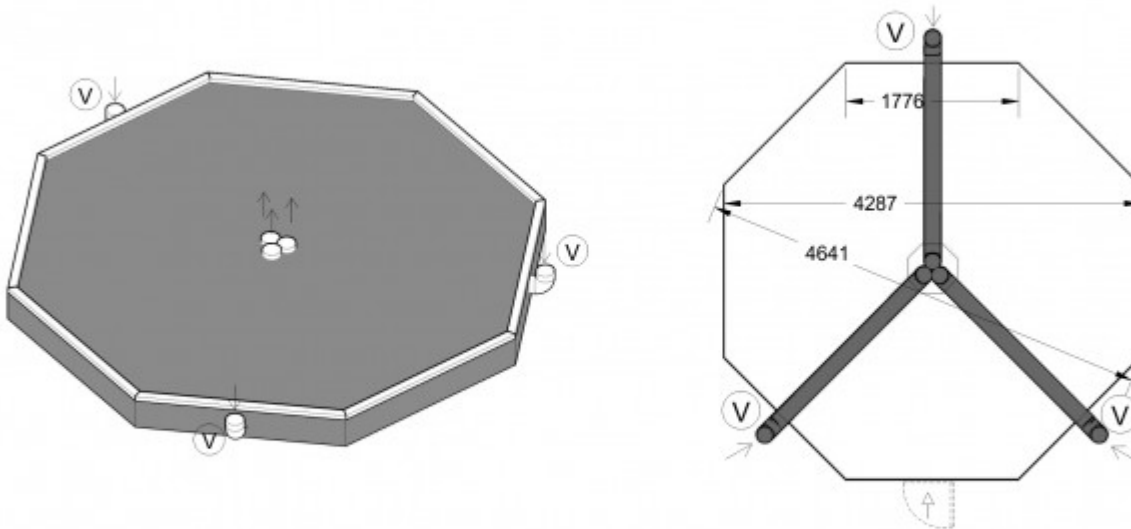

- It is very important to have a proper foundation for your Cabin. Therefore, we recommend making the foundation according to the sketches here.
- First, the foundation must be prepared according to the landscape and ground conditions.
- The foundation under the product must be prepared specially, it must be homogeneous, tight and even. It must be ensured that the foundation will not change its properties. We recommend using a concrete foundation. Before the installation of the product, we recommend using hydro isolation for the foundation.
- Consult a local qualified builder or an engineer to prepare a proper foundation, which fits your location.
- Due to the improper foundation, structures may crack. Due to uneven product seating, the geometric shape of the building may change, which can result in twisted doors/windows, or/and a gap may appear. The worst-case scenario – the building may collapse.

If you do not follow recommendations for building the base, the product will lose its warranty!

PAINTING

COLOR CARD

EXTERIOR WOOD STAIN COLORS



Water-based, quick drying premium total protection for wood outside.
Thin layer varnish – 3 in 1: impregnation, primer, and varnish!

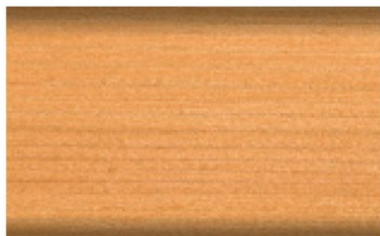

PINE / LARCH RC260

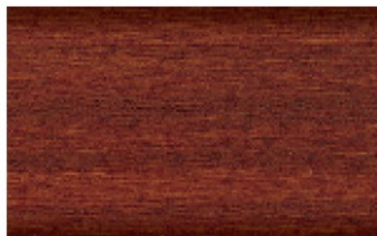

TEAK RC545

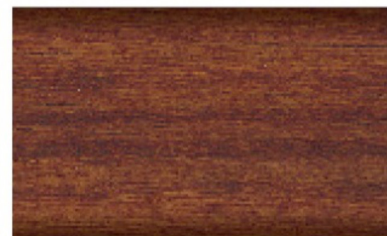

CHESTNUT RC555

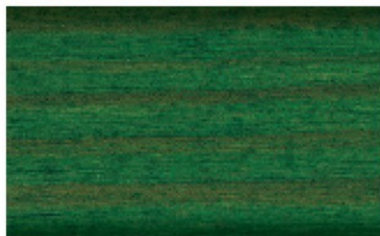

FIR GREEN RC960

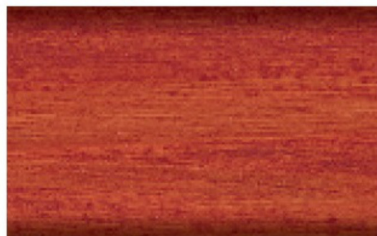

MAHAGONY RC565

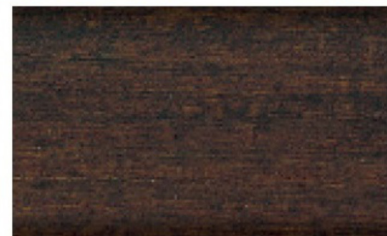

PALISANDER RC720



SILVER GREY RC970

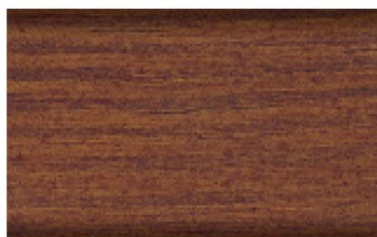

NUT WOOD RC660



PINE RC270

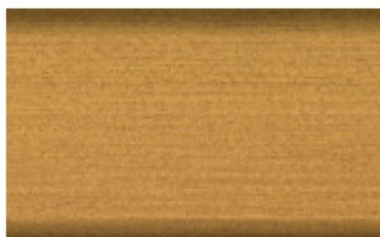

RUSTIC OAK RC360



LIGHT OAK RC365



HEMLOCK RC120



WHITE RC990

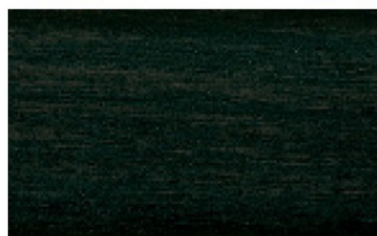

EBONY RC790

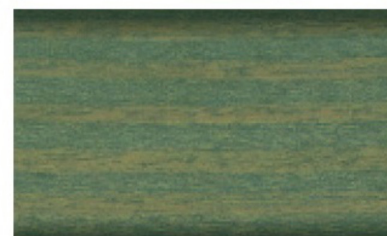

SALT GREEN RC965

PLEASE NOTE: The colors shown in the catalogue and website may not 100% match the color you will receive.
The color of the wood material affects the final color.

PAINTING

COLOR CARD

EXTERIOR WOOD PAINT COLORS

Weather protection, water-based paints. High-performance and environmentally friendly.

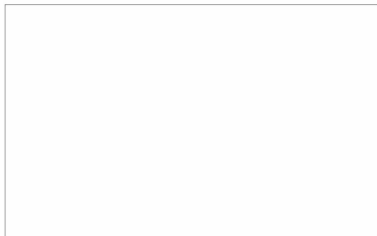

WHITE / RAL 9016



ANTRACITE GREY / RAL 7016

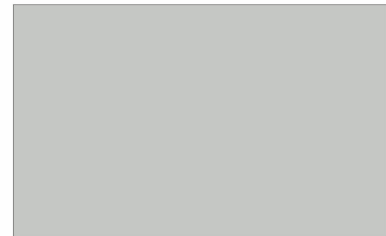

LIGHT GREY / RAL 7035



DUSTY GREY / RAL 7037

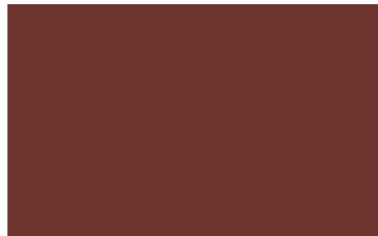

OXIDE RED / RAL 3009



JET BLACK / RAL 9005



MOSS GREEN / RAL 6005



AZURE BLUE / RAL 5009

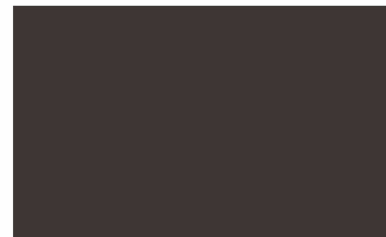

GREY BROWN / RAL 8019



BROWN RED / RAL 3011

PLEASE NOTE: The colors shown in the catalogue and website may not 100% match the color you will receive. The color of the wood material affects the final color.

PAINTING

AUTOMATIC MACHINE SPRAY TECHNOLOGY

Benefits

One of the main and most obvious benefits of using a paint machine is the speed and flexibility at which we can suggest our painting service for all of our products. A spray paint machine can get the work done faster and more consistently than manually painting. While the machine works faster, it improving quality too – sprayers produce an even coat of paint, leaving a high-quality finish.

With our painting service from now, we can suggest to our client's maximum flexibility! Not assembled products as Grill cabins, Pavilions, Camping pods, and other products of any size you can order painted too!

PROFESSIONAL SPRAY

The high-quality preservative finish is professionally spray applied in the factory to one side of the wood. The product is treated in your choice of color. You can choose two colors for one product: one for almost all product details and another for finishing details.

STAIN | PAINT

Which type of painting should i Use?

Properly painting and impregnating is one of the most important things to consider when thinking about how to extend your product lifetime.

Paint and natural wood finish instantly spruce up the aesthetics of your product.

The decision you will need to make is if you want to use a water-based wood stain or paint. Both will offer you UV protection. The wood stains will allow the texture of the wood to show through and many are now available in a vast range of colors, however, paints will give you an intensive color, but will cover the grain and texture of the wood.

USAGE AND MAINTENANCE

USAGE.

- **The first time you'll use your Grill the surfaces of the new product that are in direct contact with the flames may create a smoky smell when heating up.** We advise to keep the door open during the first use and not to cook until the smell disappears.
- When burning wood we recommend to use Grill table metal safety fence.
- We suggest you to use only firewood or briquettes. Larger burning objects can be added later when the fire is burning well. We advise to use objects no larger than 300 mm.
- A sufficient flow of fresh air is the most essential aspect of smoke exhaustion. At least as much fresh air should come in as goes out with the smoke.
- If the Grill is generating a lot of smoke, open the door of the Grill Cabin and make sure that the wood is dry and without a bark. Put in additional dry wood if needed.
- Keep decorations away from your Grill. Hanging decorations look pretty, but provide fuel for a fire.
- Keep water nearby for flare-ups.
- **Keep a fire extinguisher within a couple steps of your Grill.** And KNOW HOW TO USE IT!
- **Don't leave a Grill unattended.** Don't allow kids or pets to play near the Grill. Never try to move hot Grill, and remember the Grill will stay hot for at least an hour after its use.
- Do not sleep in a Grill Cabin when the fire is on!
- Use protective gloves when handling hot cooking plates. **Never move or service an operating Grill.**
- Please note, that the metal Grill may have sharp edges and the steel parts of the Grill heats up when the fire is burning, therefore there is risk to harm or burn yourself.
- Remove ashes from the Grill after they have cooled down.
- Make sure you give yourself time to clean your Grill after each use in order to ensure maximum hygiene and proper functioning.

MAINTENANCE.

You should not forget that wood is a natural material, it changes and moves depending on weather conditions. Large and small cracks, color tone differences and other changes, as well as a changing structure of wood are not defects, but a result of wood growing and a feature of wood as a natural material. Natural wood (not impregnated) becomes grayish after being left untouched for a while, and can turn blue and become moldy. You should immediately process it with wood preservative to protect the wooden parts of our manufactured products.

We definitely recommend that you process the door and windows with a wood preservative, and do it on both sides (inside and outside), because the doors and windows can deform. Also, you should pre-treat the floor panels with a wood preservative, especially the bottom sides of the panels, to which you will no longer have access when the Cabin is assembled. Only this will prevent moisture penetration.

In general, we recommend for the conclusive finishing a weather protection paint that will protect wood from moisture and UV radiation after the Cabin is assembled. Consult a specialist regarding paints suitable for unprocessed softwood and follow the paint manufacturer's instructions. Your Grill Cabin service life will be much longer after it will be properly painted. **We recommend that you inspect your Cabin thoroughly once every six months.**

Customer should make sure that air circulation is working in winter as well. It means that air pipes are open all year around and that moisture gets out from the product (through chimney). Customer should also make sure that product's roof is not covered by snow. A layer of snow cannot be thicker than 20 cm on the roof and the flue should never be covered by snow or closed manually.



Misko 25, LT-85302 Venta, Lithuania
info@vikingindustrier.com